

**FK600**

**THERMO-COOKERS "CLASSICA"**



mm 600x600xh860

CE EN -12815 certification

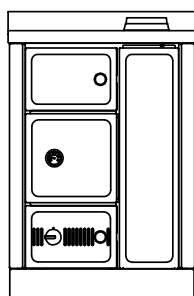
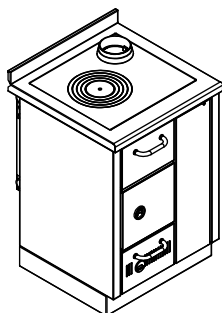

ARTE 11



ARTE 12



ARTE 13



ARTE 14

Colours:

White enamel, glazed black enamel, shaded brown enamel, stainless steel  
(stainless steel satin-finished or brass handles)

Version Arte 11, 12, 13, 14:

White, Blue, Green, Black, Red, Ivory, Copper

(choice of knobs: nickel-plated, satin-finished, polished brass)

**STANDARD EQUIPMENT**

- cast-iron hotplate mm 310x450 with cooking rings set
- right top flue outlet  $\varnothing$  140 mm
- s.steel frame of mm 40 (total height 860 mm)
- stainless steel base h. 100 mm height and depth adaptable

**BY REQUEST**

- safety heat exhaust outfitted for close circuits implants
- right rear or side flue outlet  $\varnothing$  140 mm
- glass-ceramic hotplate (rear flue only)

**OPTIONALS**

- front handrail s.steel or brass, 2 or 3 sides
- heavy-duty radiant hotplate
- stainless steel hotplate cover

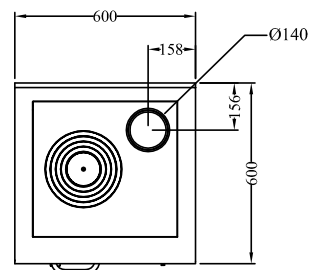
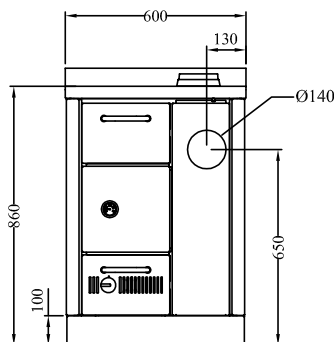
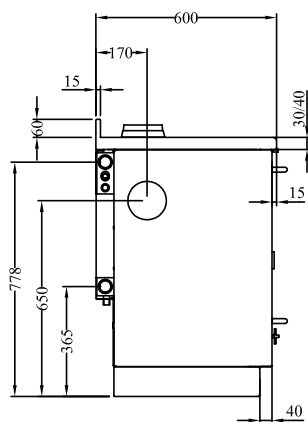

- 1 Out connection 1" 1/4 female
- 2 In connection 1" 1/4 female
- 3 Connection for thermal outflow circuit 1/2" male (by request)
- 4 Connection for thermal outflow tube 1/2" female (by request)

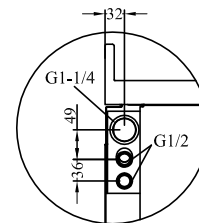
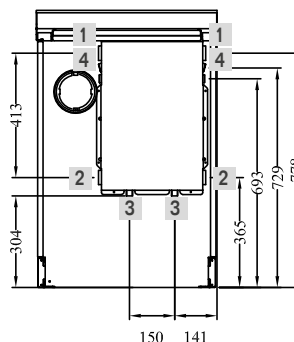

**DATA SHEET**

Nominal heat output (max): 14 (22) kw	Nominal water heat output (max): 10.5 (18) kw
Mean content of CO to 13% O <sub>2</sub> : 0.21 %	Efficiency: 71 %
Maximum operating pressure: 1.5 bar	Boiler capacity: 20 Lt
Hearth dimensions (LxPxH): 25x45x22/50 cm	Fill opening (LxH): 21x17 cm
Mean flue gas temperature: 254 °C	Flue gas mass flow: 30.9 g/s
Flue depression: mbar 0.12	Net weight/packaging included: kg 170/185